

DWG. No./Part No.:					CODE:	DESCRIPTION:	MATERIAL:	FINISH:	
HTN-61P					S	HAND-TIGHT NUT, W/PLASTIC HANDLE, CGA-320		TO BE FREE FROM OIL AND DIRT	
REV	ECN	DATE	CHKD	APPVD	TOLERANCES UNLESS SPECIFIED:		NOTICE: THE DATA IN THIS DOCUMENT INCORPORATES PROPRIETARY INFORMATION AND RIGHTS OF SUPERIOR PRODUCTS, INC. CONFIDENCE AND AGREES THAT IT SHALL NOT BE DUPLICATED IN WHOLE OR IN PART, NOR DISCLOSED TO OTHERS WITHOUT THE WRITTEN CONSENT OF SUPERIOR PRODUCTS, INC.	INTERPRET GEOMETRIC TOLERANCING PER: ANSI Y14.5	DO NOT SCALE
A	REDRAWN	07/27/07	GDG	PSM	T25 FINISH ALL OVER REMOVE ALL BURRS BREAK ALL CORNERS .015/.005 DECIMAL .XX +/- .015 .XXX +/- .005 ANGULAR +/- 1 CONCENTRICITY .007 TIR				

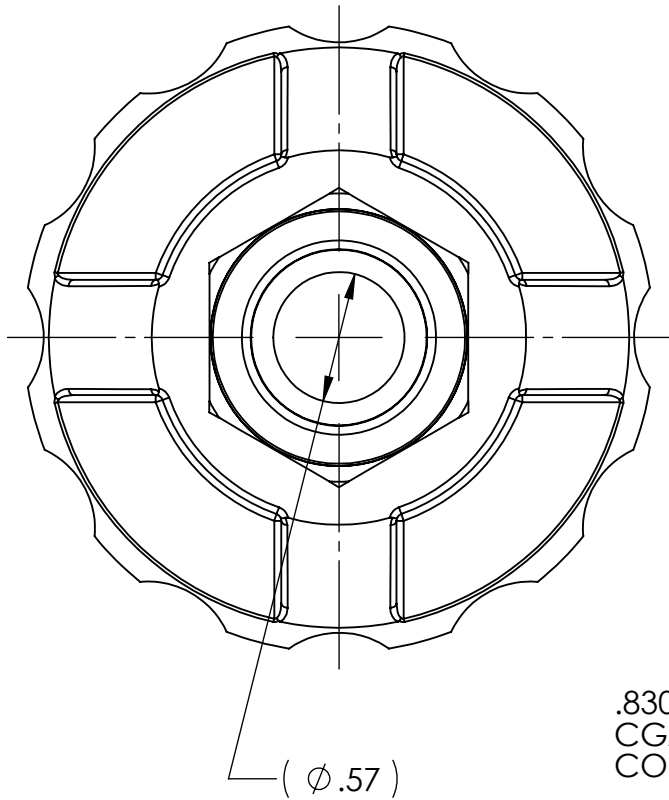

.830-14 RH NGO
 CGA - V1
 CONN - 320

